

NEW SYSTEM

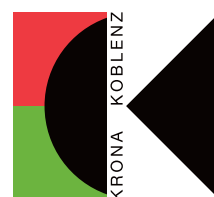

PAT-PENDING

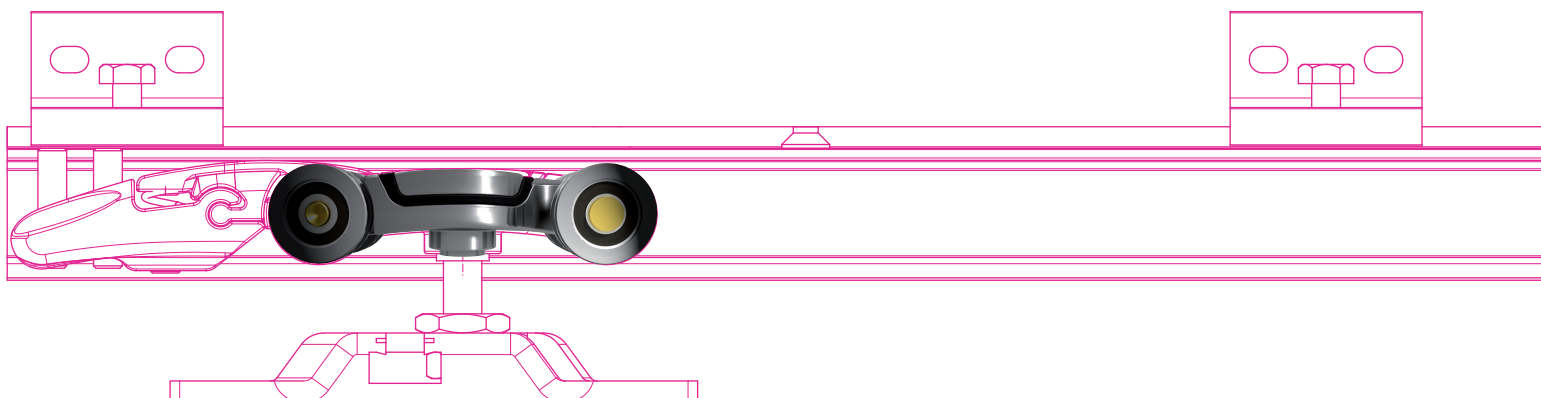

NEW SYSTEM



- I Soluzione per porta in legno scorrevole
- E Solución para puerta corredera en madera
- D Holzschiebetür-Lösung

- UK Solution for a wooden sliding door
- F Solution pour porte coulissante en bois
- RUS Решение для раздвижной деревянной двери

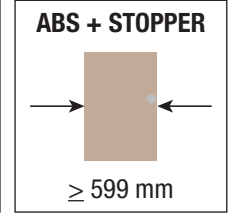
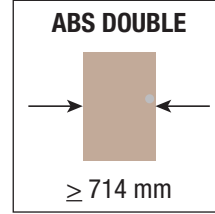
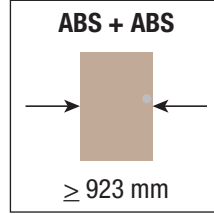
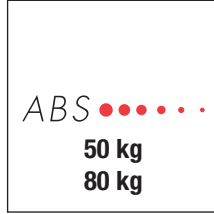
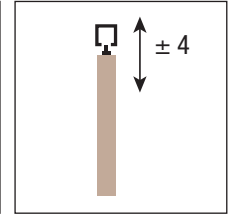
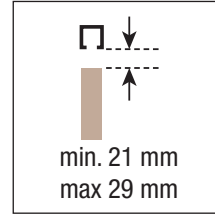
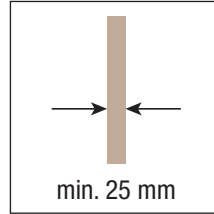
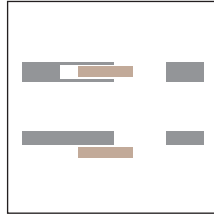
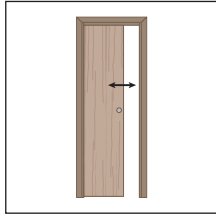

BASIC

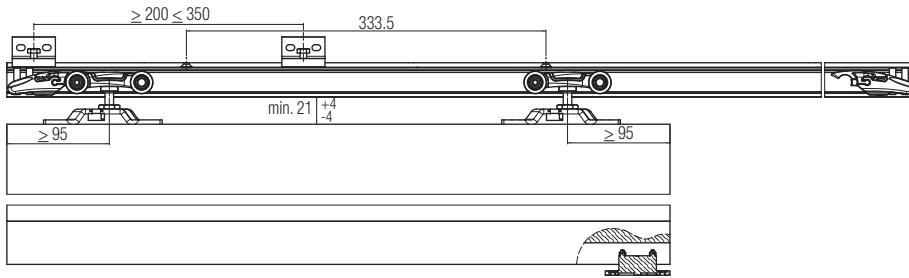

ABS + ABS

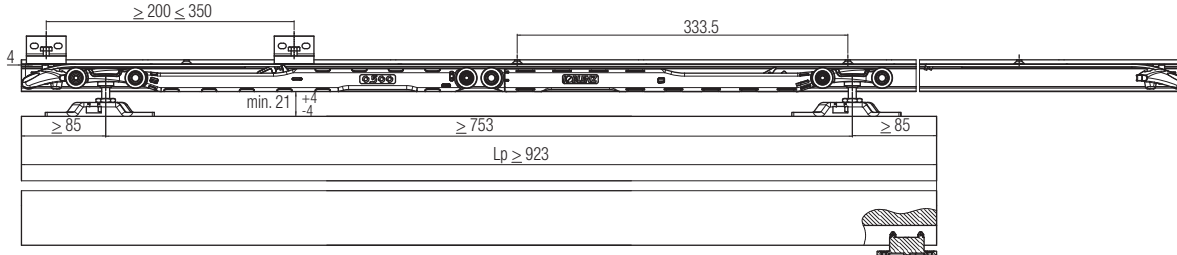

ABS DOUBLE

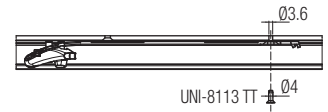
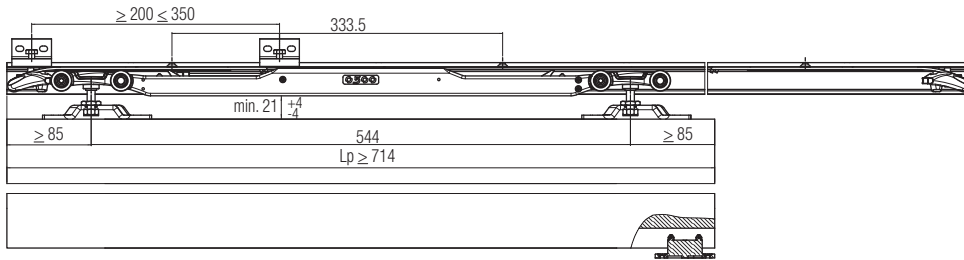

ABS + STOPPER

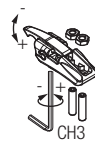
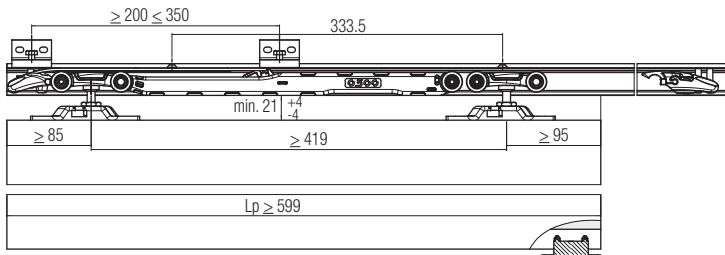

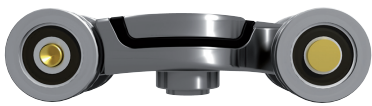

- I Soluzioni scorrevoli realizzabili
- E Soluciones correderas realizables
- D Ausführbare Schiebetür-Lösungen

- UK Possible sliding solutions
- F Solutions réalisables avec portes coulissantes
- RUS Возможные решения для раздвижных дверей

